



# **AP-A**

## **Dental Air Polisher Instruction manual**

*Please read this manual before operating*

**CE** 0197

**GUILIN WOODPECKER MEDICAL INSTRUMENT CO., LTD.**

## Contents

Preface.....	1
1 Introduction.....	1
2 Installation and Operation.....	2
3 Troubleshooting .....	8
4 Cleaning, Disinfection and Sterilization .....	9
5 Maintenance, storage and transportation .....	15
6 Environment protection .....	17
7 After service .....	17
8 European authorized representative.....	18
9 Symbol instruction .....	18
10 EMC-Declaration of conformity.....	19
11 Statement.....	23

## **Preface**

Guilin Woodpecker Medical Instrument Co., Ltd is a professional manufacturer researching, developing, and producing dental products. Woodpecker owns a sound quality control system and two brands, Woodpecker and DTE. Its main products include dental scaler, dental air polisher, Ultrasurgery, root canal motor, Curing light, dental implant unit, endo motor, etc.

## **1 Introduction**

AP-A Dental Air polisher uses compressed air to drive the prophylaxis powder and spray water together on the tooth surface to remove the attachments on the tooth surface (such as dental plaque, pigment, soft dirt, etc.), the features of this device are as follows:

- 1) Water and power can be adjusted.
- 2) The handpiece is designed in three sections, it's easy to assemble and disassemble, and easy to clean.
- 3) The handpiece can be free to plug, and can be sterilized in the environment of 134°C and 0.22MPa pressure.

### 1.1 Product model

AP-A

### 1.2 Product Configuration

For more information, see packing list.

### 1.3 Structure and components

It mainly consists of main unit, handpiece, nozzle, foot switch, powder tank, water bottle, power adapter, prophylaxis powder, etc.

### 1.4 Intended use

AP-A Dental Air Polisher is used to remove plaque and pigment, and maintain the implant.

### 1.5 Contraindication

- 1.5.1 The hemophilia patient is forbidden to use this device.
- 1.5.2 Heart disease patients, pregnant women and children should be cautious to use the device.
- 1.5.3 Patients with respiratory diseases such as asthma and chronic bronchitis are not allowed to use this device.

### 1.6 device security classification

- 1.6.1 Classification by operation mode: Continuous operating device

- 1.6.2 Type of protection against electric shock: Class I
- 1.6.3 Degree of protection against electric shock: B type applied part
- 1.6.4 Degree of protection against harmful ingress of water: Ordinary device (IPX0). Foot switch is anti-drip device (IPX1).
- 1.6.5 The contact duration time of applied part:  
Nozzle: Less than 10 minutes
- 1.6.6 The temperature of the surface of nozzle may reach 45°C if it is used at maximum power.

## 1.7 Main technical specification

- 1.7.1 Power adapter input: 100-240V~ 50/60Hz 1.1A Model: USE48-300130SPA3
- 1.7.2 Main unit input: 30V---1.3A
- 1.7.3 Main unit insurance: T1.6AL 250V
- 1.7.4 Air inlet pressure: 5.5bar ~ 7.5bar(0.55MPa ~ 0.75MPa)
- 1.7.5 Main unit weight: 2.0kg
- 1.7.6 Main unit size: length×width×height 270mm×170mm×90mm

## 1.8 Operation environment

- 1.8.1 Environment temperature: + 5°C ~ + 40°C
- 1.8.2 Relative humidity: 30% ~ 80%
- 1.8.3 Atmospheric pressure: 70kPa ~ 106kPa

## 1.9 Intended place of use

Professional healthcare facility environment.

# **2 Installation and Operation**

## 2.1 Main unit and main accessories display

### 2.1.1 Front view of main unit

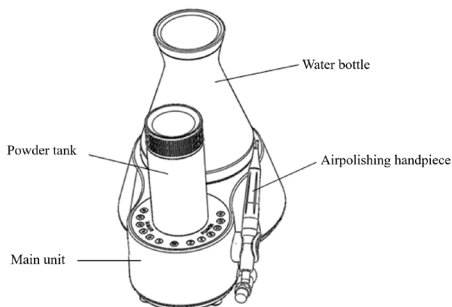

Fig. 1 Front view of main unit

### 2.1.2 Back view of main unit

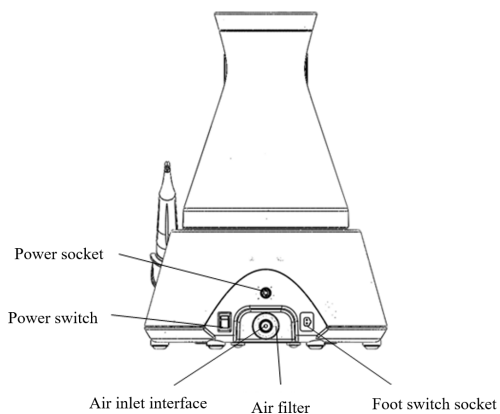

Fig. 2 Back view of main unit

### 2.1.3 Touch panel

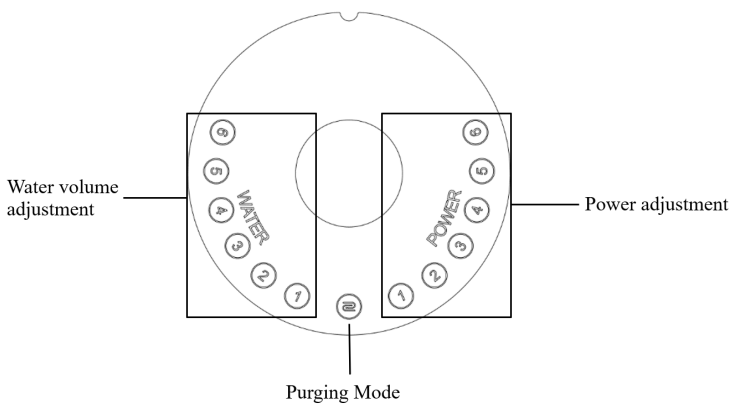

Fig. 3 Touch panel

After power on, the button will be blue. If there is no air connection or the air pressure is insufficient, the blue light flashes.

### 2.1.4 Schematic diagram of handpiece

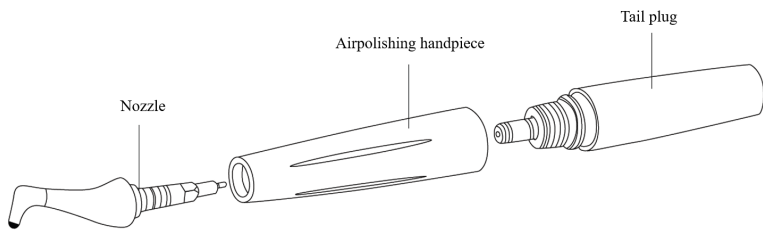

Fig. 4 Airpolishing handpiece

## 2.2 Main unit installation

- 1) Open the package, check whether all the accessories of this device are complete according to the packing list, and put the main unit on the stable desktop to the operator.
- 2) Take out the foot switch and insert the connector into the corresponding foot switch socket on the back of the main unit.
- 3) Take out the external air pipe and connect the air pipe joint with the air inlet interface on the back of the main unit.
- 4) Put the power switch in the off state, insert the output plug of the power adapter into the power socket on the back of the main unit, and then insert the input plug of the power adapter into the power socket.
- 5) Release the foot pedal, the handle can stop working, and press the power switch to shut down.

**[Warning 1]** To avoid the risk of electric shock, this equipment must only be connected to a supply mains with protective earth.

**[Warning 2]** When the power adapter is connected to the network power supply, do not place or install the product in a place where it is difficult to cut off the network power supply.

**[Warning 3]** Unauthorized modification of this equipment is not allowed.

**[Warning 4]** This equipment cannot be used in areas where liquids may appear on the floor such as emergency rooms or surgical operating rooms.

**[Warning 5]** This equipment can only be used by professionals with a physician or nurse license.

**[Warning 6]** The device is expected to be connected to an independent power supply, and the power supply shall be specified as part of the device or the combination of device and power supply shall be specified as the ME system.

**[Warning 7]** Use of this equipment adjacent to or stacked with other

equipment should be avoided because it could result in improper operation. If such use is necessary, this equipment and the other equipment should be observed to verify that they are operating normally.

**[Warning 8]** Use of accessories, transducers and cables other than those specified or provided by the manufacturer of this equipment could result in increased electromagnetic emissions or decreased electromagnetic immunity of this equipment and result in improper operation.

## 2.3 Instructions

### 2.3.1 Handpiece connection

Take out the airpolishing handpiece, connect the air polishing handpiece with the airpolishing line, and place the handpiece on the bracket on the right side of the main unit.

### 2.3.2 Filling with prophylaxis powder

Take out the powder tank and use the three way syringe to blow away the residual powder. Take out the prophylaxis powder, hold the bottle and shake it 3-5 times, then pour the powder into the powder tank.

When the powder in the powder tank is used up, please click the “Purging Mode” button twice to remove the compressed air in the powder tank, and then add powder into powder tank. It is unallowed to add powder when in use.

[Tip 1] Do not exceed the maximum (MAX) mark.

[Tip 2] The supragingival powder can only be used in the supragingival powder tank. The subgingival powder can only be used in the subgingival powder tank.

### 2.3.3 Filling with water

Take out the water bottle, add purified water (or distilled water) to the water bottle, and then plug the water bottle into the main unit. A small amount of Vaseline can be applied to the seal ring at the bottom of the water bottle to lubricate the seal ring, which is convenient for the water bottle to plug.

### 2.3.4 Supragingival airpolishing

2.3.4.1 Assess the patient's oral condition, set the power and water level in advance, and It is recommended that the power starts from the 2nd gear, and the water volume starts from the 3rd gear.

According to the sensitivity and comprehensive situation of the patient's oral cavity, adjust the water and power level at any time during the scaling process.

2.3.4.2 Before the treatment, please spray in the external container for 1-3 seconds in advance to ensure that the gas and water are evenly sprayed.

2.3.4.3 Before air polishing, please wear goggles and veil. Users should wear goggles or protective masks.

2.3.4.4 Hold the handpiece like holding a pen.

2.3.4.5 Make the nozzle align with the tooth surface. It is recommended that the nozzle outlet keep a distance of 3-5mm from the tooth surface. It is recommended that the air polishing direction and the tooth surface show an angle of 30°-60°, as shown in fig. 5.

2.3.4.6 Use the high-speed evacuation device on the dental comprehensive treatment machine to absorb the air/powder mixture reflected from the tooth surface during treatment

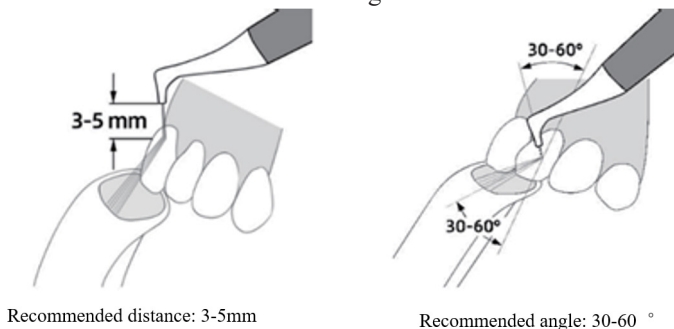

Fig. 5 schematic diagram of grit blasting on gum

### 2.3.5 Subgingival airpolishing

2.3.5.1 When the depth of the patient's periodontal pocket exceeds 4mm, subgingival airpolishing is recommended.

2.3.5.2 Install the nozzle before use, take out the nozzle assemble the nozzle to the end of the subgingival handpiece. Rotate the nozzle nut to the head handpiece first, and then lock the nozzle with a wrench, as shown in Fig. 6.

2.3.5.3 Assess the periodontal condition of patients and set the power and water level in advance. It is recommended that the power starts from the 1st gear and the water starts from the 3rd gear. Adjust the water and power level at any time during the scaling process. s according to the periodontal sensitivity and oral comprehensive situation of patients.

2.3.5.4 Hold the handpiece like holding a pen.

2.3.5.5 It is recommended to use the nozzle to remove the plaque of



the 4-9mm depth periodontal pocket, pull up and down when using.

2.3.5.6 It is not allowed to polishing the periodontal pocket at each point for more than 5 seconds. [Tip 3] It is forbidden to pull out the handpiece in the working state.

[Tip 4] When subgingival airpolishing, it's just allowed use subgingival powder, and misusing powder may cause harm to patients.

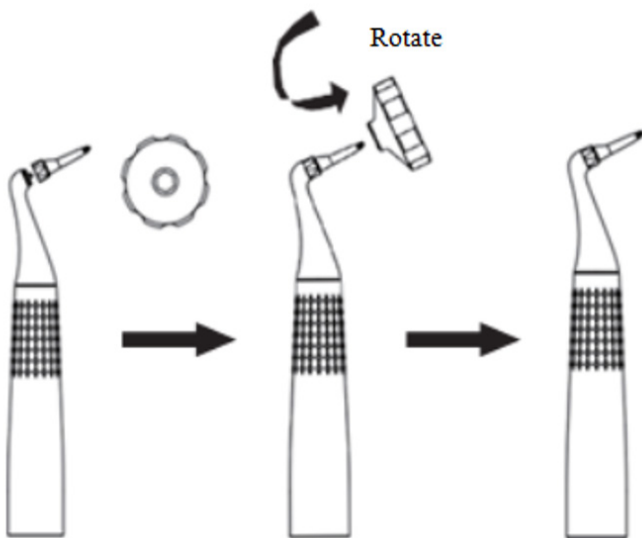

Fig. 6 Nozzle locking

## 2.4 Maintenance

### 2.4.1 Airpolishing handpiece

2.4.1.1 Remove the air polishing handpiece, loosen the handpiece head and pull out the handpiece head (For subgingival handpiece, the nozzle needs to be removed in advance), as shown in fig. 7.

2.4.1.2 Align the handpiece head with a three way syringe and blow away the residual powder in the handpiece.

2.4.1.3 Blow the front and rear ends of the handpiece with a three way syringe.

2.4.1.3 If the handpiece is blocked, use needle to dredge it.

2.4.1.4 Handpieces, water bottles and powder tanks should not be maintained when they are being used.

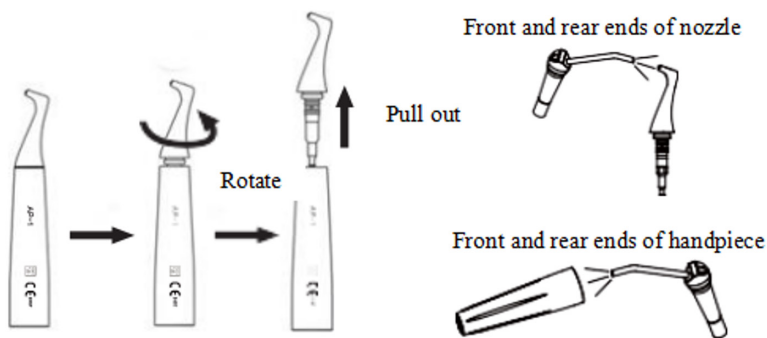

Fig. 7 handpiece cleaning diagram

#### 2.4.2 Powder tank

2.4.2.1 It is recommended to estimate the amount of prophylaxis powder before use. It is easy to cause blocked that leaving extra powder in the powder tank for a long time because the powder will clump in a humid environment. Therefore, please pour out the powder remaining in the powder tank after use.

2.4.2.2 Use a three way syringe to clean the powder remaining in the powder tank, and blow away the powder in the thread of the powder and powder tank lid.

#### 2.4.3 Daily maintenance

Before and after using airpolishing system, please click the "purge" button on the main unit.

### 3 Troubleshooting

Failure	Possible cause	Solutions
After power-off, there is still water spray.	Impurity in the solenoid valve.	Contact local distributors or manufacturer.

There is air flow but no water spray.	Unconnected air source or low air pressure ( $\leq 3\text{bar}$ ).	Check the air connection and ensure that the pressure meets the requirements of the device (5bar-7bar).
	Handpiece blocked.	Use nozzle to dredge handpiece.
	Tail line blocked.	Contact local distributors or manufacturer.
	The internal pipeline of the main unit is blocked.	Contact local distributors or manufacturer.
	Solenoid valve failure.	Contact local distributors or manufacturer.
There is air spray but no water.	Solenoid valve failure.	Contact local distributors or manufacturer.
	Solenoid Valve blocked due to impurities.	Open the main unit dredge solenoid valve or contact local distributors or manufacturer.
There is no air and water spray.	Abnormal foot switch connection.	Reconnect foot switch.
	Foot failure.	Repair or replace foot switch.
Powder tank leakage	Seal ring damaged.	Replace seal ring.
Airpolishing handpiece leakage.	Tail line seal ring damaged, deformed or missing.	Replace seal ring.
Handpiece plug difficult.	Handpiece snap ring deformation	Replace snap ring.

Note: If the fault cannot be removed, please contact your local distributor or manufacturer.

## 4 Cleaning, Disinfection and Sterilization

## 4.1 Initial processing

### 4.1.1 Processing principles

It is only possible to carry out effective sterilization after the completion of effective cleaning and disinfection. Please ensure that, as part of your responsibility for the sterility of products during use, only sufficiently validated device and product-specific procedures are used for cleaning/disinfection and sterilization, and that the validated parameters are adhered to during every cycle.

Please also observe the applicable legal requirements in your country as well as the hygiene regulations of the hospital or clinic, especially with regard to the additional requirements for the inactivation of prions.

### 4.1.2 Post-operative treatment

The post-operative treatment must be carried out immediately, no later than 30 minutes after the completion of the operation. The steps are as follows:

Let the device work for 20-30 seconds at maximum water volume to separately flush the Air polishing handpiece, and nozzle;

Remove the handpieces from the device and rinse away the dirt on the surface of handpieces and their accessories with pure water (or distilled water/deionized water);

Dry the handpieces and its accessories with a clean, soft cloth and place it in a clean tray.

Precautions:

1) The water used here must be pure water, distilled water or deionized water.

## 4.2 Cleaning

The cleaning of handpiece and its accessories should be performed no later than 24 hours after the operation.

The cleaning can be divided into automated cleaning and manual cleaning. Automated cleaning is preferred if conditions permit.

### 4.2.1 Automated cleaning

The cleaner is proved to be valid by FDA, CE certification or in accordance with EN ISO 15883.

There should be a flushing connector connected to the inner cavity of the product.

The cleaning procedure is suitable for the handle, and the flushing period is sufficient.

It is recommended to use a washer-disinfector in accordance with EN

ISO 15883.

For the specific procedure, please refer to the automated disinfection section in the section “Disinfection”.

Precautions:

- 1) The cleaning agent does not have to be pure water. It can be distilled water, deionized water or multi-enzyme. But please ensure that the selected cleaning agent is compatible with the handpiece.
- 2) The water temperature should not exceed 45°C, otherwise the protein will solidify and it is difficult to remove.

#### 4.2.2 Manual cleaning

- Soak the handpieces and its accessories in a cleaning agent (such as multi-enzyme). The soaking time and concentration should at least reach the time and concentration specified by the detergent manufacturer;
- Carefully clean the surface of the handpieces and its accessories with a disposable soft cloth or soft brush to remove any visible dirt on the surface;
- Rinse the handpieces and its accessories under clean running water (desalted water, distilled water or deionized water) for at least 5 times with duration of no less than 60 seconds for each time.
- Check whether the cleaned parts are clean or damaged. If the cleaning is not complete, repeat the previous cleaning procedures.

The intrinsic suitability of the handpieces and its accessories for effective cleaning using the above procedure was verified by a validated facility.

Precautions:

- 1) The cleaning agent used here must be compatible with the handpieces and only freshly prepared solutions can be used.
- 2) The water temperature should not exceed 45°C, otherwise the protein will solidify and it is difficult to remove.

### 4.3 Disinfection

Disinfection must be performed no later than 2 hours after the cleaning phase. Automated disinfection is preferred if conditions permit.

#### 4.3.1 Automated disinfection

If possible, the disinfection cycle should be in accordance with EN ISO 15883. Please ensure that the following standards are met when selecting a sterilizer system:

- The sterilizer is FDA approved, CE certified or in accordance with EN ISO 15883.

- Use high temperature disinfection function. The temperature does not exceed 134 °C. The temperature cannot exceed 20 minutes.
- The sterilizer has a flush connecting piece that is connected to the interior of the handpiece.
- The cleaning procedure is suitable for the handle and the flushing cycle is sufficient (5-10 minutes).
- Only distilled or deionized water with a small amount of microorganisms (<10cfu/ml) can be used for all rinsing steps. (For example, pure water that is in accordance with the European Pharmacopoeia or the United States Pharmacopoeia).
- The air used for drying must be filtered by HEPA.
- Regularly repair and inspect the disinfectant.

Cleaning and disinfecting steps by using Washer-disinfectant Carefully place the handpieces and its accessories in the disinfection basket.

Fastening of the handpieces and its accessories if only permissible if they are freely moveable in the fixture. The handpieces and its accessories are not permitted to make contact with one another.

Use a suitable rinsing adaptor, and attach the handpieces to the rinsing connections of the washer-disinfectant so that the surface and internal water lines can be flushed during cleaning process.

Start the program.

After the program is finished, remove the handpieces and its accessories from the washer-disinfectant, inspect (refer to section “Inspection and Maintenance”) and packaging (refer to chapter “Packaging”). Dry the handpieces and its accessories repeatedly if necessary (refer to section “Drying”).

The intrinsic suitability of the handpieces and its accessories for effective cleaning and disinfection using the above automated cleaning and disinfection procedures was verified by a certified facility. (Use the washer-disinfectant of Shandong Xinhua Medical Instrument Co., Ltd. located in Zibo City, Shandong Province, which complies with EN ISO 15883).

Precautions:

- 1) Before use, you must carefully read the operating instructions provided by the device manufacturer to familiarize yourself with the disinfection process and precautions.
- 2) With this device, cleaning, disinfection and drying will be carried out together.
- 3) Cleaning: (a) The water temperature should not exceed 45°C, otherwise the protein will solidify and it is difficult to remove. (b)

The solution used can be pure water, distilled water, deionized water or multi-enzyme solution, etc., and only freshly prepared solutions can be used. (c) The cleaning agent must be compatible with the handpiece. Please follow the concentration and contact time provided by manufacturer.

#### 4.3.2 Manual disinfection

Tools: containers for disinfectant, water guns, air guns, trays

Place the handpieces and its accessories in a disinfectant (e.g. 75% medical alcohol or 2% glutaraldehyde solution) for at least the time specified by the manufacturer. Remove the handpieces and its accessories from the disinfectant and rinse it with purified water, distilled water or deionized water for at least 5 times for not less than 60 seconds of each time.

Dry the handpieces and its accessories with filtered compressed air (maximum pressure: 3 bar).

After the program is finished, remove the handpieces and its accessories from the washer-disinfector, inspect (refer to section “Inspection and Maintenance”) and packaging (refer to chapter “Packaging”). Dry the handpieces and its accessories repeatedly if necessary (refer to section “Drying”).

Verification of the fundamental suitability of the handpieces and its accessories for effective manual cleaning and disinfection was provided by a verified testing laboratory.

Precautions:

- 1) The disinfectant used to configure the disinfectant must be compatible with the handpieces and cleaning agent, and must be tested effective (e.g., DGHM, FDA approved or CE certified).
- 2) The disinfectant must be used in accordance with the concentration and contact time specified by manufacturer.
- 3) The disinfectant used must be freshly prepared solutions and no foaming is allowed.

#### 4.4 Drying

If your cleaning and disinfection process does not have an automatic drying function, dry it after cleaning and disinfection.

Methods:

- 1) Spread a clean white paper (white cloth) on the flat table, point the handpieces and its accessories against the white paper (white cloth), and then dry the handpieces and its accessories with filtered dry compressed air (maximum pressure 3 bar). Until no liquid is sprayed

onto the white paper (white cloth), the drying is completed.

2) It can be dried directly in a medical drying cabinet (or oven). The recommended drying temperature is 80°C~120°C and the time should be 15~40 minutes.

Precautions:

- 1) The drying of product must be performed in a clean place.
- 2) The drying temperature should not exceed 138°C;
- 3) The device used should be inspected and maintained regularly.

#### 4.5 Inspection and maintenance

1) Check the handpieces and its accessories. If there is still visible stain on the handpieces and its accessories after cleaning/disinfection, the entire cleaning/disinfection process must be repeated.

2) Check the handpieces and its accessories. If it is obviously damaged, smashed, detached, corroded or bent, it must be scrapped and not allowed to continue to be used.

3) Check the handpiece. If the structural parts are broken, please replace it before use. But the replaced parts must be cleaned, disinfected and dried.

5) Do not use the machine when the machine is being cleaned/disinfected/sterilized.

#### 4.6 Packaging

The disinfected and dried handpieces and their accessories are assembled and quickly packaged in a medical sterilization bag (or special holder, sterile box).

Precautions:

- 1) The package used conforms to ISO 11607;
- 2) It can withstand high temperature of 138°C and has sufficient steam permeability;
- 3) The packaging environment and related tools must be cleaned regularly to ensure cleanliness and prevent the introduction of contaminants;
- 4) Avoid contact with parts of different metals when packaging.

#### 4.7 Sterilization

Use only the following steam sterilization procedures (fractional pre-vacuum procedure\*) for sterilization, and other sterilization procedures are prohibited:

The steam sterilizer complies with EN13060 or is certified according to EN 285 to comply with EN ISO 17665;

The highest sterilization temperature is 138°C;



The sterilization time is at least 4 minutes at a temperature of 132°C / 134°C and a pressure of 2.0 bar ~ 2.3 bars.

Allow a maximum sterilization time of 20 minutes at 134°C.

Verification of the fundamental suitability of the products for effective steam sterilization was provided by a verified testing laboratory.

Precautions:

- 1) Only products that have been effectively cleaned and disinfected are allowed to be sterilized;
- 2) Before using the sterilizer for sterilization, read the Instruction Manual provided by the device manufacturer and follow the instructions.
- 3) Do not use hot air sterilization and radiation sterilization as this may result in damage to the product;
- 4) Please use the recommended sterilization procedures for sterilization. It is not recommended to sterilize with other sterilization procedures such as ethylene oxide, formaldehyde and low temperature plasma sterilization. The manufacturer assumes no responsibility for the procedures that have not been recommended.

If you use the sterilization procedures that have not been recommended, please adhere to related effective standards and verify the suitability and effectiveness.

\*Fractionation pre-vacuum procedure: a procedure for steam sterilization by repeating pre-vacuum, the procedure used here is steam sterilized by three pre-vacuums.

## **5 Maintenance, storage and transportation**

### 5.1 Maintenance

5.1.1 It is recommended to install air drying device (such as freezing dryer) in advance before using air polishing device. And check drying device every day to ensure it work normally. Otherwise it may be easy to cause prophylaxis powder agglomerating. And the agglomerating will cause the device or handpiece blocked.

5.1.2 Check sealing ring on the handpiece, tail line, powder tank, water bottle regularly. If finding defects such as rupture, deformation or falling off, please refer to the instructions and replace them in time, the accessories are equipped with sealing rings of corresponding specifications.

5.1.3 Check the air inlet interface filter once a month to confirm whether there is impurity in the filter. If there is impurity, replace

the filter in time, and check the cleanliness of the air compressor and the environment where it is located. If there is no impurity, it is recommended to replace the filter every 24 months. Spare filters are included in accessories. The way to replace filter are shown in Figure 8.

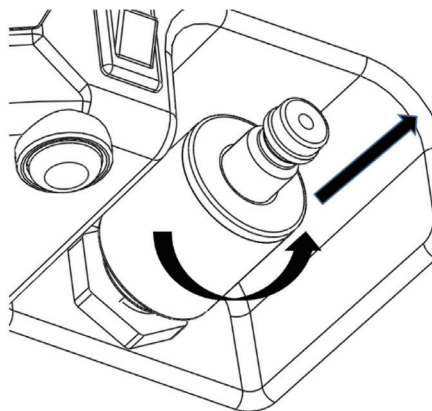

Fig. 8 Schematic diagram of filter replacement

## 5.2 Storage

5.2.1 This device should be carefully placed away from the source, and should be installed or stored in a cool, dry and ventilated place.

5.2.2 Do not mix with toxic, corrosive, flammable and explosive articles during storage.

5.2.3 The product should be stored in an environment where the relative humidity is 10% ~ 93%, the atmospheric pressure is 70kPa ~ 106kPa, and the temperature is -20°C ~ + 55°C.

5.2.4 When this device is not in use for a long time, it should be powered on and ventilated once a month, at least five minutes each time.

## 5.3 Transportation

5.3.1 Excessive impact and shake should be prevented during transport. Lay it carefully and lightly.

5.3.2 Do not put it together with dangerous goods during transport.

5.3.3 Avoid being exposed to sun, rain, and snow during transport.

## 6 Environment protection

Please discard waste, debris and expired machines or components in accordance with local regulations.

Part	Toxic or harmful substances or elements					
	(Pb)	(Hg)	(Cd)	(Cr6+)	(PBB)	(PBDE)
Main unit	○	○	○	○	○	○
Motor handpiece	○	○	○	○	○	○
Dental contra-angle	○	○	○	○	○	○
Mechanical elements, including bolts, nuts, washers, etc.	○	○	○	○	○	○

○: Indicates that the content of the toxic substance in all homogeneous materials of the part is below the limit requirement stipulated in SJ/T-11363-2006 Limit Requirements for Toxic and Hazardous Substances in Electronic Information Products.

×: indicates that the content of the toxic substance in at least one of the homogeneous materials of the part exceeds the limit requirement specified in SJ/T-11363-2006. Please dispose according to the local laws or consult with dealer from whom you purchased it about waste disposal.

## 7 After service





















We offer one year free repair to the device according to the warranty card. The repair of the device should be carried out by professional technician. We are not responsible for any irretrievable damage caused by non-professional person. This product is a precision device.

If there is problem that needs to be repaired, returned to Woodpecker or handled by professionals is recommended. If any component part needs to be replaced, please contact Woodpecker for relevant information. Please use accessories or component parts provided or approved by Woodpecker. Using other accessories or component parts may cause equipment failure and unacceptable risks.

## 8 European authorized representative

**EC REP** MedNet EC-Rep GmbH  
Borkstrasse 10 · 48163 Muenster · Germany

## 9 Symbol instruction

	Follow Instructions for Use		CE marked product
	Date of manufacture		Manufacturer
	Type B applied part		Recovery
	Handle with care		Keep dry
<b>IPX0</b>	Ordinary device	<b>IPX1</b>	Anti-drip device
	Used indoor only		Purging mode
	Alternating current		Foot switch
	Protective earthing		Sterilization under high temperature
	Power Switch	<b>DC30V</b>	30V DC
	Direct current		Cooling water or flushing water
	Appliance compliance WEEE directive		
	Storage condition, humidity limit: 10% ~ 93%		
	Storage condition, air pressure limit: 70kPa ~ 106kPa		
	Storage condition, temperature limit: -20°C ~ +55°C		

## 10 EMC-Declaration of conformity

A list of all cables are replaceable by the RESPONSIBLE ORGANIZATION :

Port No.	Name	Type*	Cable maximum lengths
1	Enclosure	N/E	—
2	AC Mains	AC power port	1.5m
3	Airpolishing handpiece Cable	PATIENT COUPLING PORT	1.7m
4	FOOT sw. Cable	SIP / SOP PORT	2.4m
5	DC Mains of adapter	DC power port	1.5m

### Guidance and manufacturer's declaration - electromagnetic emissions

The model AP-A is intended for use in the electromagnetic environment specified below. The customer or the user of the model AP-A should assure that it is used in such an environment.

Emissions test	Compliance	Electromagnetic environment - guidance
RF emissions CISPR 11	Group 1	The model AP-A RF energy only for its internal function. Therefore, its RF emissions are very low and are not likely to cause any interference in nearby electronic equipment.
RF emissions CISPR11	Class B	The model AP-A RF energy only for its internal function. Therefore, its RF emissions are very low and are not likely to cause any interference in nearby electronic equipment.
Harmonic emissions IEC 61000-3-2	Class A	
Voltage fluctuations / flicker emissions IEC 61000-3-3	Complies	

### Guidance & Declaration — electromagnetic immunity

The model AP-A 1s intended for use 1n the electromagnetic environment specified below. The customer or the user of the model AP-A should assure that It is used in such an environment.

Immunity test	IEC 60601 test level	Compliance level	Electromagnetic environment - guidance
Electrostatic discharge (ESD) IEC 61000-4-2	± 8 kV contact ± 15 kV air	± 8 kV contact ± 15 kV air	Floors should be wood, concrete or ceramic tile If floors are covered with synthetic material, the relative humidity should be at least 30 %.
Electrical fast transient/burst IEC 61000-4-4	±2kV for power supply lines ±1kV for Input/output lines	± 2kV for power supply lines ± 1kV for interconnecting cable	Mains power quality should be that of a typical commercial or hospital environment.
Surge IEC 61000-4-5	± 1 kV line to lie ± 2 kV line o earth	Line-to-line--- ± 0,5 kV, ± 1 kV Line-to-ground--- ± 0,5 kV, ± 1 kV, ± 2 kV	Mains power quality should be that of a typical commercial or hospital environment.
Voltage dips, short interruptions and voltage variations on power supply input lines IEC 61000--11	0 % UT; 0,5 cycle At 0°, 45°, 90°, 135°, 180°, 225°, 270° and 315° 0 % UT; 1 cycle and 70 % UT; 25/30 cycles Single phase: at 0° 0 % UT; 250/300 cycle	0 % UT; 0,5 cycle At 0°, 45°, 90°, 135°, 180°, 225°, 270° and 315° 0 % UT; 1 cycle and 70 % UT; 25/30 cycles Single phase: at 0° 0 % UT; 250/300 cycle	Mains power quality should be that of a typical commercial or hospital environment If the user of the model require continued operation during power mains interruptions, it is recommended that the model be powered from an uninterruptible power adapter or a battery.
Power frequency (50/60 H) magnetic field IEC 61000-4-8	30 A/m, 50 Hz and 60 Hz	30 A/m, 50 Hz and 60 Hz	Power frequency magnetic fields should be at levels charactenstlc of a typical location in a typical commercial or hospital environment.

NOTE UT is the ac mains voltage prior to application of the test level.

### Guidance & Declaration - Electromagnetic immunity

The model AP-A is intended for use in the electromagnetic environment specified below. The customer or the user of the model AP-A should assure that it is used in such an environment.

Immunity test	IEC 60601 test level	Compliance level	Electromagnetic environment - guidance
<p>Conducted RF IEC 61000-4-6 Conducted RF IEC 61000-4-6 Radiated RF IEC 61000-4-3</p>	<p>3 V, 0.15 MHz – 80 MHz, 6 V in ISM bands between 0.15 MHz – 80 MHz, 80 % AM at 1 kHz 3 V/m and 10 V/m, 80 MHz – 2,7 GHz, 80 % AM at 1 kHz 385 MHz, pulse modulation 18 Hz, 27 V/m; 450 MHz, FM +/- 5 kHz deviation 1 kHz sine, 28 V/m; 710 MHz, 745 MHz, 780 MHz, pulse modulation 217 Hz, 9 V/m; 810 MHz, 870 MHz, 930 MHz, pulse modulation 18 Hz, 28 V/m; 1,720 MHz, 1,845 MHz, 1,970 MHz, pulse modulation 217 Hz, 28 V/m; 2,450 MHz, pulse modulation 217 Hz, 28 V/m; 5,240 MHz, 5,500 MHz, 5,785 MHz, pulse modulation 217 Hz, 9 V/m</p>	<p>3 V, 0.15 MHz – 80 MHz, 6 V in ISM bands between 0.15 MHz – 80 MHz, 80 % AM at 1 kHz 3 V/m and 10 V/m, 80 MHz – 2,7 GHz, 80 % AM at 1 kHz 385 MHz, pulse modulation 18 Hz, 27 V/m; 450 MHz, FM +/- 5 kHz deviation 1 kHz sine, 28 V/m; 710 MHz, 745 MHz, 780 MHz, pulse modulation 217 Hz, 9 V/m; 810 MHz, 870 MHz, 930 MHz, pulse modulation 18 Hz, 28 V/m; 1,720 MHz, 1,845 MHz, 1,970 MHz, pulse modulation 217 Hz, 28 V/m; 2,450 MHz, pulse modulation 217 Hz, 28 V/m; 5,240 MHz, 5,500 MHz, 5,785 MHz, pulse modulation 217 Hz, 9 V/m</p>	<p>Portable and mobile RF communications equipment should be used no closer to any part of the models AP-A, including cables, than the recommended separation distance calculated from the equation applicable to the frequency of the transmitter. Recommended separation distance  <math>d=1.2 \times P^{1/2}</math>  <math>d=2 \times P^{1/2}</math>  <math>d=1.2 \times P^{1/2}</math> 80 MHz to 800 MHz  <math>d=2.3 \times P^{1/2}</math> 800 MHz to 2.7 GHz            where P is the maximum output power rating of the transmitter In watts (W) according to the transmitter manufacturer and d Is the recommended separation distance in meters (m).            Field strengths from fixed RF transmitters, as determined by an electromagnetic site survey, a should be less than the compliance level in each frequency range. b            Interference may occur In the vicinity of equipment marked with the following symbol:  </p>

NOTE 1 At 80 MHz - 800 MHz, the higher frequency range applies.

NOTE 2 These guidelines may not apply in all situations. Electromagnetic propagation is affected by absorption and reflection from structures, objects and people.

a Field strengths from fixed transmitters, such as base stations for radio (cellular/cordless) telephones and land mobile radios, amateur radio, AM and FM radio broadcast and TV broadcast cannot be predicted theoretically with accuracy. To assess the electromagnetic environment due to fixed RF transmitters, an electromagnetic site survey should be considered. If the measured field strength in the location in which the model is used exceeds the applicable RF compliance level above, the model should be observed to verify normal operation. If abnormal performance is observed, additional measures may be necessary, such as reorienting or relocating the model.

b Over the frequency range 150 kHz to 80 MHz, field strengths should be less than 3V/m.

### **Recommended separation distances between portable and mobile RF communications equipment and the model**

The model is intended for use in electromagnetic environment in which radiated RF disturbances is controlled. The customer or the user of the model can help prevent electromagnetic interference by maintaining a minimum distance between portable and mobile RF communications equipment (transmitters) and the model is recommended below, according to the maximum output power of the communications equipment.

Rated maximum output power of transmitter W	Separation distance according to frequency of transmitter m		
	150kHz to 80MHz $d=1.2 \times P^{1/2}$	80MHz to 800MHz $d=1.2 \times P^{1/2}$	800MHz to 2,7GHz $d=2.3 \times P^{1/2}$
0,01	0.12	0.12	0.23
0,1	0.38	0.38	0.73
1	1.2	1.2	2.3
10	3.8	3.8	7.3
100	12	12	23

For transmitters rated at a maximum output power not listed above, the recommended separation distance d in meters (m) can be estimated using the equation applicable to the frequency of the transmitter, where P is the maximum output power rating of the transmitter in watts (W) accordable to the transmitter manufacture.

NOTE I At 80 MHz - 800 MHz, the separation distance for the higher frequency range applies.

NOTE II These guidelines may not apply in all situations. Electromagnetic propagation is affected by absorption and reflection from structures, objects and people.



The device has been tested and homologated in accordance with EN 60601-1-2 for EMC. This does not guarantee in any way that this device will not be affected by electromagnetic interference. Avoid using the device in high electromagnetic environment.

## **11 Statement**

Woodpecker reserves the right to change the design of the device, the technique, fittings, instruction manual and the content of the original packing list at any time without further notice. The pictures are only for reference. The final interpretation rights belong to Guilin Woodpecker Medical Instrument Co., Ltd. The appearance of the product was authorized patent, and counterfeit will be sued!  
(Please refer to the packaging label for the date of manufacture.  
Service life: 10 years)

Scan and Login website  
for more information



Guilin Woodpecker Medical Instrument Co., Ltd.  
Information Industrial Park, Guilin National High-Tech  
Zone, Guilin, Guangxi, 541004 P. R. China  
Sales Dept.: +86-773-5873196  
[Http://www.glwoodpecker.com](http://www.glwoodpecker.com)  
E-mail: [woodpecker@glwoodpecker.com](mailto:woodpecker@glwoodpecker.com)



MedNet EC-Rep GmbH  
Borkstrasse 10 · 48163 Muenster · Germany

ZMN-SM-490 V1.0-20220222